



# REPUESTOS ESPAÑA

Soportería en Lamina para Automotores

## SOPORTES KODIAK

REFERENCIA	APLICACION
------------	------------

CH 032 SP	KODIAK TRASERO PARTE DELANTERO	Ref original 15641041 Para pasador de 7/8 Para resorte de 3"
-----------	--------------------------------	--

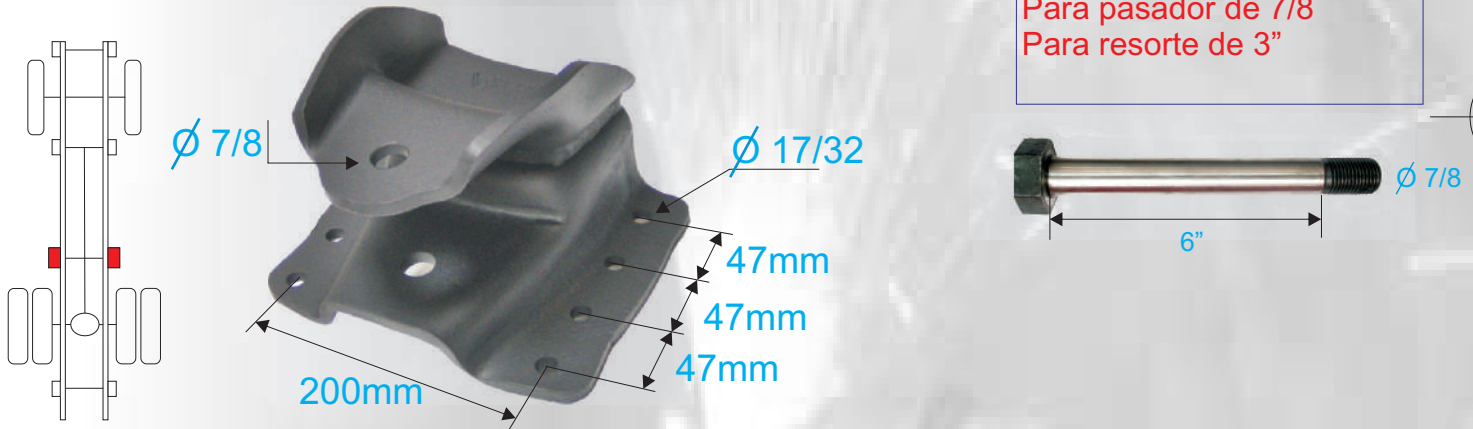

REFERENCIA	APLICACION
------------	------------

CH 033 SP	KODIAK TRASERO PARTE TRASERA	Ref original 15641043 Para pasador de 1/2 Para resorte de 3"
-----------	------------------------------	--

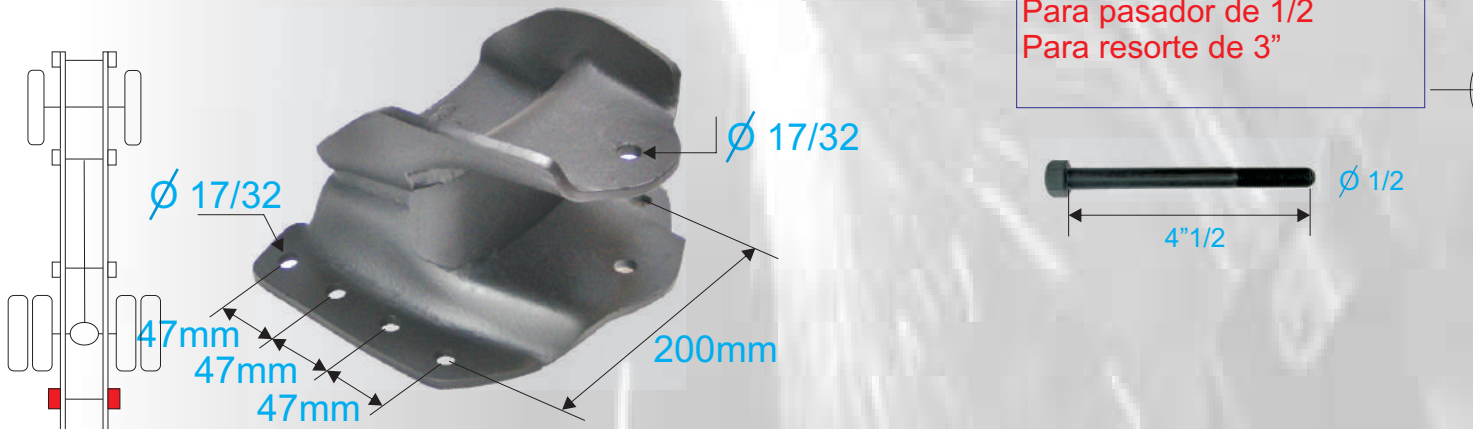

REFERENCIA	APLICACION
------------	------------

CH 623 SP	KODIAK TRASERO PARTE TRASERA	Ref original 15641042 Para pasador de 1/2 Para resorte de 3"
-----------	------------------------------	--

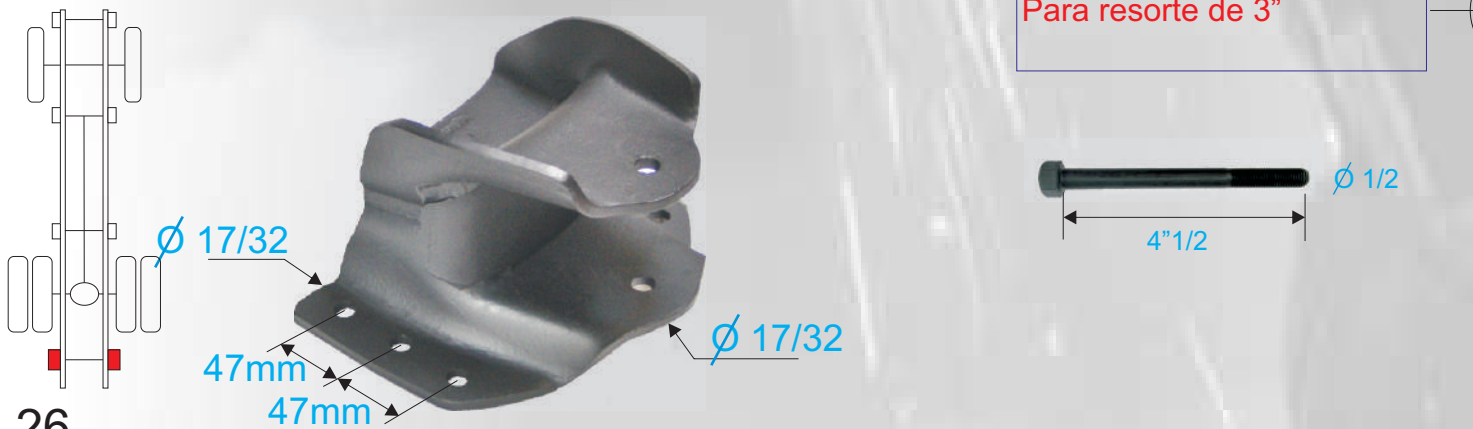



# REPUESTOS ESPAÑA

Soportería en Lamina para Automotores

## SOPORTES KODIAK

REFERENCIA	APLICACION
------------	------------

CH 034 SP	KODIAK TRASERO PARTE TRASERA LARGO	Para pasador de 1"1/4 Para resorte de 3"
-----------	------------------------------------	---

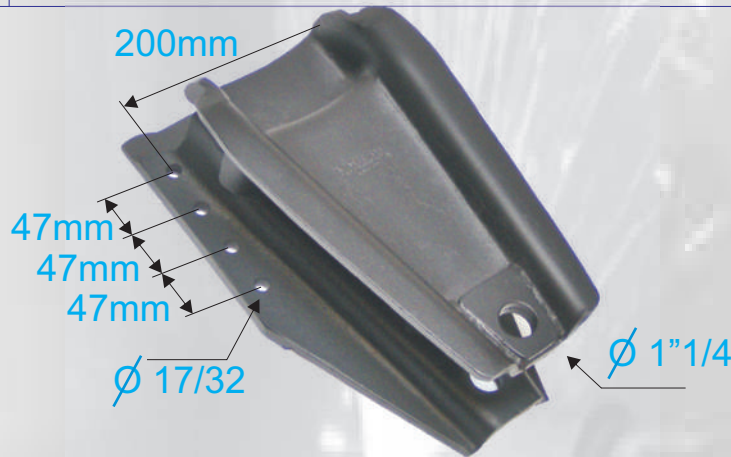
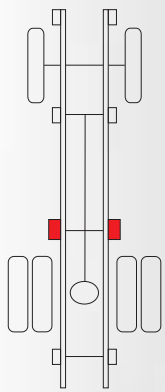
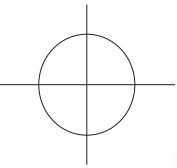

REFERENCIA	APLICACION
------------	------------

CH 035 SP	KODIAK DELANTERO PARTE TRASERA	Ref original 15609889 Para pasador de 20mm Para resorte de 3" Para balancín CH 071 BAL
-----------	--------------------------------	---

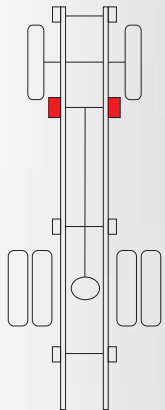
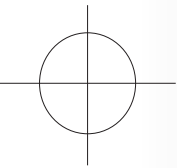

REFERENCIA	APLICACION
------------	------------

CH 036 SP	B70 KODIAK DELANTERO PARTE DELANTERA	Ref original 15654693 Para pasador de 20mm Para resorte de 3"
-----------	--------------------------------------	---

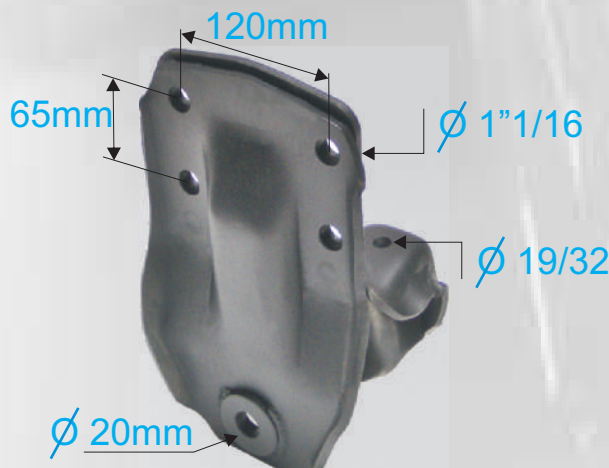
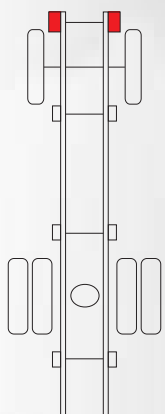
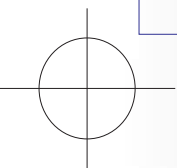



# REPUESTOS ESPAÑA

Soportería en Lamina para Automotores

## SOPORTES KODIAK

REFERENCIA	APLICACION
------------	------------

CH 599 SP	KODIAK DELANTERO PARTE DELANTERA
-----------	----------------------------------

Ref original 15071511  
Para pasador de 20mm  
Para resorte de 3"

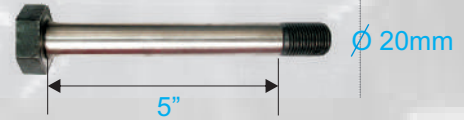
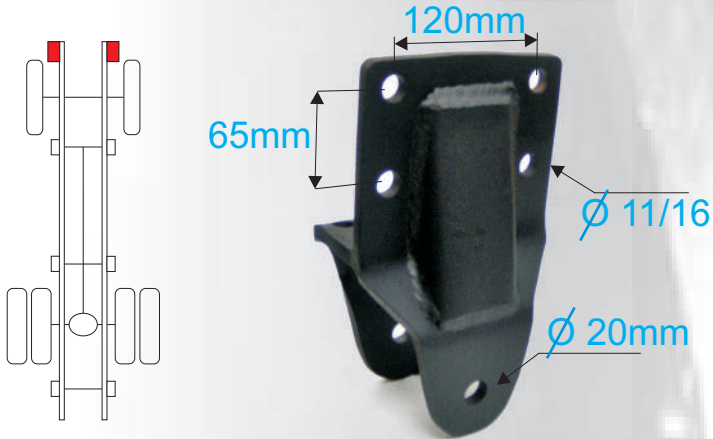

REFERENCIA	APLICACION
------------	------------

CH 037 SP	ABRAZADERA ESTABILIZADORA KODIAK
-----------	----------------------------------

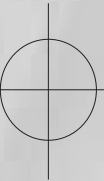
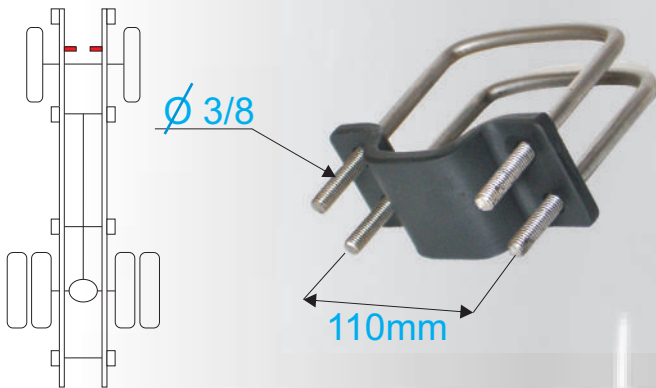

REFERENCIA	APLICACION
------------	------------

CH 435 SP	SPARTA TRASERO PARTE TRASERA
-----------	------------------------------

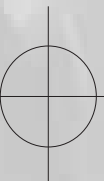



# REPUESTOS ESPAÑA

Soportería en Lamina para Automotores

## SOPORTES NPR

REFERENCIA	APLICACION	
CH 038 SP	NPR TRASERO PARTE TRASERA DERECHO	Ref original 894820991 Para pasador de 5/8 Para resorte de 70mm

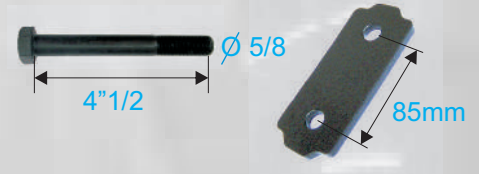
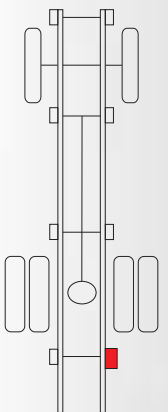
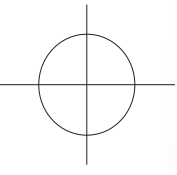

REFERENCIA	APLICACION	
CH 039 SP	NPR TRASERO PARTE TERASERA IZQUIERDO	Ref original 894820991 Para pasador de 5/8 Para resorte de 70mm

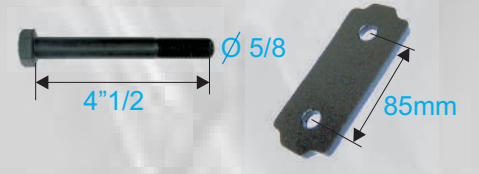
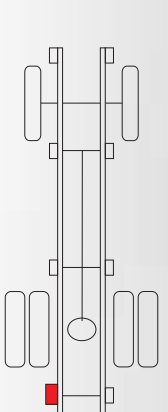
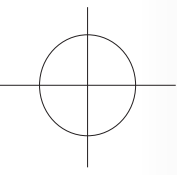

REFERENCIA	APLICACION	
CH 487 SP	NPR TRASERO PARTE TRASERA DERECHO ADAPTACION PATIN	

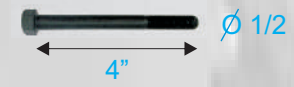
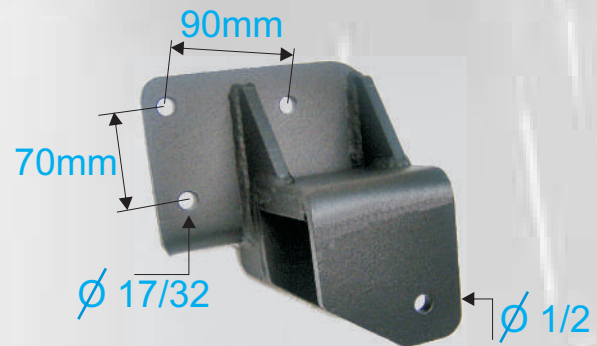
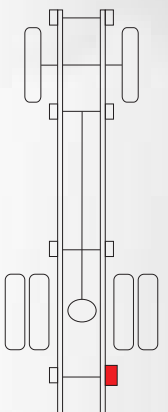
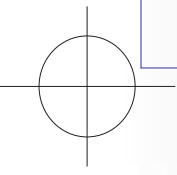



# REPUESTOS ESPAÑA

Soportería en Lamina para Automotores

## SOPORTES NPR

REFERENCIA	APLICACION
CH 488 SP	NPR TRASERO PARTE TRASERA IZQUIERDO ADAPTACION PATIN

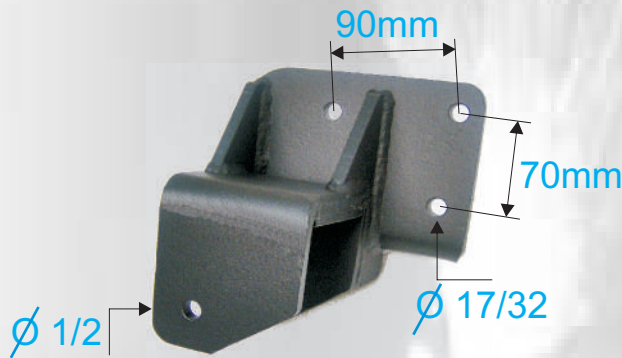
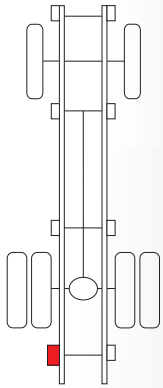

REFERENCIA	APLICACION
CH 040 SP	NPR TRASERO PARTE DELANTERO MOD 96

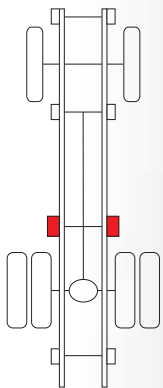

Para pasador de 25mm  
Para resorte de 70mm

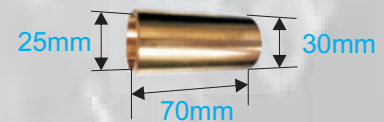
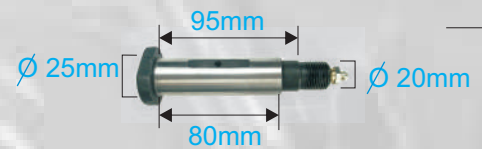

REFERENCIA	APLICACION
CH 041 SP	NPR TRASERO PARTE DELANTERO MOD 97

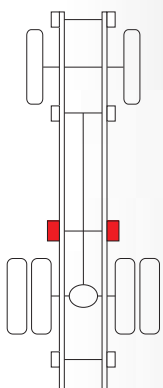

Para pasador de 18mm  
Para resorte de 70mm

